

panthera®

Operating instructions

Wheelchair model:

S3 Swing

S3 Swing Short

S3 Swing Low 0°

S3 Swing Extended 25

S3 Swing Long

Panthera S3 Swing

INNEHÅLL	SID
Introduction/ Designed for purpose	2
Design/ Contact/ Symbols	3
Description	4
Overview	5
Safety regulations	6-11
Transfer/ Lifting	10
Settings	11-15
Accessories	16-18
Transportation	18-21
Crash test	22
Maintenance / Service/ Repair	23-24
Guarantee / Conformity	25
Technical facts	26-30



INTRODUCTION

Congratulations on choosing a wheelchair from Panthera AB. We hope you will be satisfied with your Panthera model and wish you many happy years together. All of Panthera AB's products are designed and assembled in Spånga, outside Stockholm. Our models are constructed to be the very best on the market with regard to quality, manoeuvrability and low weight.

Please ensure you carefully read the instructions.

To view the images and text more clearly, you can also read the instructions digitally at www.panthera.se

DESIGNED FOR PURPOSE

Panthera S3 Swing wheelchairs are built for individuals who need a manual dynamic wheelchair for everyday use, both inside and outside the home. These wheelchairs are made to be used by people with physical disabilities, and are not limited to people with a specific diagnosis. Each person's individual function capacity and limitations indicates whether a manual dynamic wheelchair is suitable as a mobility aid. Wheelchair model recommendations should be given by trained healthcare professionals, and the appropriate product should then be tested and adjusted by an expert for the optimal sitting and driving characteristics. The wheelchair's design and settings are tested for each individual, and the product is not suitable for children.

The wheelchair is designed for indoor and outdoor use, on smooth surfaces (e.g., wood, laminate, tile, concrete, asphalt, etc.) without obstacles. Avoid grass, gravel and other uneven surfaces.

DESIGN

Panthera S3 Swing wheelchairs are designed with a focus on good ergonomics when sitting or driving. The wheelchair is designed so that it can be easily lifted into the car by the user. In addition, the chassis is formed to provide a balanced, effortless grip when lifting the chair into the car. The wheelchair's exterior is small and it is very light. If required, the wheelchair can also be equipped with a range of accessories, such as an anti-tip device, push handles, arm rests or side guards.

(To see available accessories for this wheelchair, visit www.panthera.se)

For maximum weight of user, see Technical facts.

INDICATIONS FOR USE

Panthera mechanical wheelchairs are manually operated multifunctional wheelchairs designed for indoor / outdoor use and intended to provide mobility to persons that have the capability of operating a mechanical wheelchair.

CONTACT













If you have any questions or need help with the product, contact your local supplier (Assistance centre) first. To get in touch with the manufacturer, see the details below:

Panthera AB +46 (0)8-761 50 40
Gunnebogatan 26 www.panthera.se
SE-163 53 Spånga panthera@panthera.se

SYMBOLS

The symbols used in the instructions and on the wheelchair and what they mean are listed below.

Caution: Federal law (USA) restricts this device to sale by or on the order of a physician

	Caution		Width of Wheelchair Seat
	Consult Instructions for Use		Article Number on the Chassis
	Manufacturer		Article Number on the Label and Revision
	Date of manufacture		Prescription use (USA)
	Serial Number		Medical device
	Catalog Number		CE marking
	Max.wheelchair user weight		

DESCRIPTION (Fig. 1 och 2)

Panthera S3 Swing models are dynamic wheelchairs designed to let you live life as actively as possible. The low weight, combined with the stable, fixed frame and castors with a unique profile on the tread surface, make the wheelchair extremely easy to manoeuvre. The chassis' seat angle, along with adjustable backrest and seat upholstery and backrest tilt function, combine to provide extremely good seating comfort.

The wheelchair's balance point can be adjusted to enable you to find a setting that makes you feel safe and secure. Accessories such as armrests and side guards boast a unique design, and you can adjust the height and fore-aft position of the armrests yourself without using tools. The soft upper section of the side guards folds down when loaded, for example, when the user transfers into or out of the wheelchair. You can also place your hands on the side guards when lifting yourself up or down. The aesthetically integrated anti-tip devices can be folded in and out by the user while seated in the wheelchair.

Panthera S3 Swing, Fig. 1 och 2,

Is equipped with swing away foot support with foldable footplates. The locking mechanism of the foot support is discreetly integrated, with a grip friendly, ergonomically design. You can easily swing away or remove one or both the foot support to make room for your legs and then use your feet to move about with the wheelchair. When the foot support is out of the way, transitions also becomes easy. Panthera S3 Swing has a seat angle of 4 degrees, which opens up new possibilities to find a good sitting position even for those who needs to use their legs to move about with the wheelchair or for other reasons need to have a more flat sitting position.

S3 Swing is also available as S3 Swing Short, S3 Swing Low 0° and S3 Swing Extended 25. S3 Swing–short has a 50 mm shorter chassis. S3 Swing Low 0° has a flat seat angle and S3 Swing Extended 25 is 25 mm longer than S3 Swing.



Fig. 1



Fig. 2

OVERVIEW (Fig. 3)



Fig. 3



1. Footrest
2. Chassis
3. Seat cushion
4. Armrest
5. Backrest/Backrest upholstery
6. Rear wheel/Tyres
7. Push rim
8. Brake
9. Quick release
10. Air valve
11. Rear axle
12. Castors
13. Fork
14. Connective tubing
15. Anti-tip device
16. Foot plates
17. Push handles

SAFETY REGULATIONS

Current information

Up-to-date information on safety and product updates can be found at Panthera's website, www.panthera.se

Contraindications

Inexperienced users shall use the anti-tip devices for safety.

Verify that your wheelchair corresponds with your order:

- Measure the seat width.
- Measure the height of the backrest.
- Ensure you have received the accessories you ordered.

Conduct a technical inspection of your wheelchair, ensuring that:

- the rear wheel's quick release can easily be shifted in and out of its casings.
- the rear wheel is firmly attached following installation.
- the quick release button springs out fully while in locked position.
- all four wheels are in contact with the floor.
- the Castor fork can be rotated with ease.
- the backrest folds down easily.
- the foldable footrest locks in their position.



Balance and tipping capacity

The angle of the backrest, the adjustment of the backrest upholstery and the position of the rear wheel are the most significant factors affecting the wheelchair's balance and tendency to tip. After adapting your wheelchair, check that you **feel confident about the balance of the wheelchair**.

The tipping capacity of the wheelchair may also be affected if a bag is hung on the backrest, if you lean or stretch backwards, if the tyres are worn or contain insufficient air or if there is an unexpected change to the surface you are driving on.



Anti-tip device

Panthera wheelchairs are designed to be as manoeuvrable as possible, which means the wheelchair responds quickly and seamlessly to the actions you perform. If you perform the wrong actions you could **tip over in the wheelchair**. If you operate the wheelchair incorrectly and do not have an anti-tip device, there is a risk you may tip backwards.

The anti-tip devices are a safety feature designed to **prevent you from falling backwards in the wheelchair**. If you have the slightest doubt about the balance of the wheelchair, the anti-tip devices should always be fully extended. If you operate or use the wheelchair in such a manner that the anti-tip devices are used regularly, or if your model is equipped with electrically powered wheels, the load on the devices will increase and they must be checked daily.

SAFETY REGULATIONS

Wheelchair skills

It is important to test your **wheelchair comprehensively** and take the time required to hone your **wheelchair skills**. If you have any questions on wheelchair technique, contact the person who prescribed the wheelchair or your therapist. You are also welcome to get in touch with the team at Panthera AB.

Brakes

Your wheelchair is equipped either with brakes for each rear wheel (**high brakes**) or a **one-hand brake**. The one-hand brake can be applied by gripping with one hand rather than two. The brakes are designed as parking brakes and not for braking while in motion.

Please note. In order for the brakes to function correctly, the tyres must contain the correct air pressure. See Technical facts.

The brakes will operate less effectively if the tyres are worn or contain insufficient air pressure. If changing to a different type of tyre, always check the brakes as dimensions may vary.

If you have a high brake, be careful that your fingers do not make contact with the brake when driving with the rear wheel. When transferring sideways in and out of your Panthera, make sure you can lift yourself over the brake so that you do not sit on or get caught on it. If you use the one-hand brake and can stand up, be careful not to open the brake by accident with the back of your legs.



Driving

Before using your wheelchair outdoors, spend plenty of time honing your driving technique in a secure indoor environment with a flat surface.

Always use the anti-tip devices or ensure someone is behind you as you practise. Do not attempt to drive outdoors until you feel completely confident in your wheelchair.

At speeds above 8 km / h the risk of losing control of the wheelchair increases.

Watch out for obstacles such as doorsteps and gutters in which the small castors could become jammed, causing the user to **fall forwards**.

If the distance between the lowest point of the footrest and the surface is small (less than 40 mm) the footrest could get caught on bumps in the surface and cause you to **fall forwards**.

If you drive down a curb with the anti-tip devices folded out, they may become jammed and cause you to **fall forwards**. If you feel unsafe, fold away the anti-tip devices and ask for help. The wheelchair can also be fitted with push handles which enable the user to be driven by an assistant.

Shopping or groceries can be hung on the backrest in a bag or rucksack, but you must be fully aware that this **substantially increases the risk of the wheelchair tipping backwards**. In this case, the anti-tip devices must be folded out.

Driving on uneven or inclined surfaces increases the risk of **falling both forward or backward**.

SAFETY REGULATIONS



Wheelchair technique – Ramps and sloping surfaces, curbs and stairs

Driving up ramps and sloping surfaces (Fig. 49)

When you are going to drive up a ramp, you need to take a bit of a run-up, keep a steady speed and at the same time control your direction. Lean your upper body forwards and move both push rims with fast, powerful pulls.

Driving down sloping surfaces (Fig. 50)

When driving down sloping surfaces and slopes, it is important that you have control over your direction and speed. Lean back and allow the push rims to move slowly through your hands. You should be able to stop the wheelchair at any time by grasping the push rims.

Driving down curbs (Fig. 51, 52)

With an assistant (Fig. 51)

Place the wheelchair right next to the curb. The assistant holds the backrest bow and lifts, lifts up the castors and keeps the wheelchair in balance. Then roll both rear wheels slowly over the curb edge. Meanwhile, hold the push rims firmly with both hands until the castors are on the ground again.

Without an assistant (Fig. 52)

Place the wheelchair right next to the curb, lift up the castors and keep the wheelchair in balance. Then roll both rear wheels slowly over the curb edge. Meanwhile, hold the push rims firmly with both hands until the castors are on the ground again.



Fig. 49



Fig. 50



Fig. 51



Fig. 52

SAFETY REGULATIONS



Wheelchair technique – Ramps and sloping surfaces, curbs and stairs

Driving up and down stairs (Fig. 53)

You can negotiate stairs by taking one step at a time according to the instructions here: One assistant should stand behind the wheelchair and hold the backrest bow. The second assistant should hold on to one of the solid parts of the front frame to support the wheelchair from the front. It's important that the rear wheels has support by the ground. Never lift the wheelchair with a user sitting in the wheelchair.



SAFETY REGULATIONS

Transfer into the wheelchair

Techniques for transfer must be practised extensively together with qualified staff. The methods described below are for advisory purposes only.

Transferring into the wheelchair sideways (Fig. 4)

1. Position the wheelchair as close to you as possible.
2. Lock the brakes. Se “Brakes” under “Settings”.
3. Place one hand on the far corner of the wheelchair chassis and the other on the surface you are moving from.
4. Carefully transfer yourself into the wheelchair with good balance.

To ensure the wheelchair is as stable as possible, reverse the wheelchair by 5–10 cm before stopping to make sure the Castors are pointing forwards.

Transferring **from** the wheelchair sideways (Fig. 4)

1. Position the wheelchair as close to the surface you will be moving to as possible.
2. Lock the brakes. Se “Brakes” under “Settings”.
3. Place one hand on the far corner of the wheelchair chassis and the other on the surface you are moving to.
4. Carefully transfer yourself from the wheelchair with good balance.

To ensure the wheelchair is as stable as possible, reverse the wheelchair by 5–10 cm before stopping to make sure the Castors are pointing forwards.

Lifting while the user is in the wheelchair (Fig. 5)

If the wheelchair is to be lifted while the user remains seated, always grip the wheelchair's chassis. See arrows in Fig. 5.

Do not lift using the backrest, push handles, leg support, wheels or other movable sections.



Fig. 4



Fig. 5

SAFETY REGULATIONS

Warm or cold surfaces

If the wheelchair is exposed to sunshine for long periods, its surfaces may become extremely warm. The wheelchair's surfaces can also become very cold if it is stored or used in cold conditions.



Risk of jamming

While driving the chair, be aware of the risk of your fingers becoming jammed between the rear wheel and the brake, and between the rear wheel and side guard or armrest.

Ensure your fingers or loose items do not become trapped in the rear wheel's spokes while driving. Moreover, take special care to ensure children do not place their hands inside the spokes.



Risk of burns

If the wheelchair is equipped with friction pushrims on the drive wheels (see item 7 in Overview), there is a risk of burns to the hands and fingers if you brake the wheelchair at high speed with the hands of the pushrims, as the friction between the hand and the pushrim generates high heat.

Incidents

Any serious incident that has occurred in relation to the product should be reported to Panthera and to the Swedish Medical Products Agency, or the competent authority of the Member State in which the user and/or patient is established.

SETTINGS

When adjusting the chair to suit your sitting posture and provide the mobility you require, it is important that you make the adjustments in the correct order.

Firstly, adjust the chair to enable the correct sitting posture. Only then can you adjust the balance of the wheelchair to provide the mobility you require. This must be done in the correct sequence, as adjustments to the sitting posture affect the balance of the wheelchair.

Bear in mind that a little effort adjusting the chair to your requirements initially will be of considerable benefit for a long time to come.

Set aside a day to experiment with alternative settings and see how they feel, to ensure the sitting posture and balance of the wheelchair are just right for you.

Adjustments to the wheelchair's settings must take place in the following order:

- 1) The tension of the seat upholstery.
- 2) The height of the footrest.
- 3) The tension of the calf strap/heel strap.
- 4) The angle of the backrest.
- 5) The tension of the backrest upholstery.
- 6) The balance of the wheelchair.
- 7) The brake settings.

SETTINGS

1) The tension of the seat upholstery (Fig. 6)

The rear section of the seat upholstery can be tightened or loosened by adjusting the Velcro strap underneath.

This allows you to vary your seat height by around 2 cm upwards or downwards. The seat should be used together with a seat cushion.

2) The height of the footrest (Fig. 7)

The footrest can be adjusted either upwards or downwards.

You should adjust the footrest at a height where your thighs are supported by the seat at the same time as your feet are supported by the footplates or foot support.

Adjusting the height of the footrest:

- 1) Remove the two screws supporting the footrest on the front of the frame using a 3 mm Allen key.
- 2) You can then move the footrest up or down to fit into one of the fixed positions.
- 3) Securely tighten the two screws.

3) The tension of the calf strap/heel strap (Fig. 8 and 9)

The tension of the calf strap and heel strap will determine how far forward you can place your feet on the foot support or footplates, respectively. The suitable tension depends largely on how long or short your legs are.

Adjusting the tension of the calf strap/heel strap (Fig. 8 and 9)

- 1) Loosen the calf strap/heel strap.
- 2) Place your feet on the foot support/footplates.
- 3) Adjust the tension of the calf strap / heel strap using the Velcro strap provided.

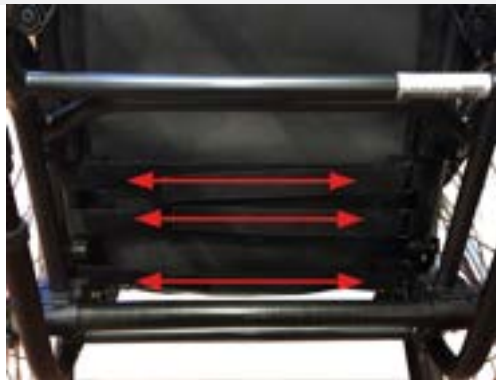

Fig. 6



Fig. 7

SETTINGS

4) The angle of the backrest (Fig. 10)

- 1) Deactivate the backrest locking function on both sides by pulling the wire (1).
- 2) Fold the backrest forwards.
- 3) Loosen the lock screws (2) a few rotations using a 4 mm Allen key. Repeat this process on the other side.
- 4) Turn the backrest lock casings (3) clockwise so that the lock faucet does not fix the backrest in place. Use the 17 mm cap key. Repeat this process on the other side.
- 5) Release the lock nuts (4) on both sides using the 17 mm cap key.
- 6) Adjust the angle of the backrest using the adjustment screws (5) on both sides. Using the 4 mm Allen key, unscrew the adjustment screws to tilt the backrest forwards. Tightening the adjustment screws will allow the backrest to tilt backwards. It is important to adjust both sides equally to avoid the backrest tubing becoming crooked. Test this by placing the backrest in the upright position and checking that both adjustment screws are touching the frame.
- 7) Experiment with suitable backrest angles before tightening the lock nuts (4) on both sides.
- 8) Place the backrest into the upright position.
- 9) Turn the backrest lock casings (3) so that the lock faucets spring out into their tracks. Use the 19 mm cap key.
- 10) Tighten the lock screws (2) on both sides using a 4 mm Allen key.



Fig. 8

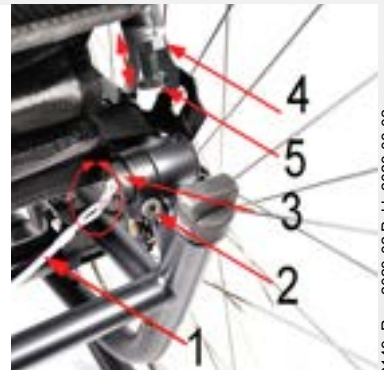

Fig. 9

SETTINGS

5) The tension of the backrest upholstery (Fig. 11)

You can adjust the backrest upholstery to suit the shape of your back using the straps located under the flap at the rear of the backrest. This provides good support to the small of the back.

The backrest upholstery also has a lower flap fastened with Velcro above the seat upholstery, under the seat cushion. This flap can be moved backwards or forwards to obtain the required tension in the lower section of the back upholstery (known as the seat bucket).

Adjusting the tension of the backrest upholstery:

- 1) Lift up the backrest upholstery's upper flap (1).
- 2) Loosen the bands.
- 3) Sit as far back in the chair as you can. If it feels as though you are not sitting far back enough in the chair, it may be because the backrest upholstery's lower flap is fastened too far forward on the seat. Loosen the flap (2) and then fasten it further back on the seat upholstery.
- 4) Tighten the bands to ensure you have the necessary support.
- 5) Fold down the backrest upholstery's upper flap (1).



6) The balance of the wheelchair (Fig. 12)

You can adjust the balance of the wheelchair by moving the rear wheel's rear axle either forwards or backwards – the further forward the rear axle is placed, the greater the wheelchair's rear balance. This is done in order to transfer more weight onto the rear wheel, making the chair lighter at the front. This makes the chair easier to manoeuvre and easier to tip up onto its rear wheels, for instance, when negotiating curbs, doorsteps and so on. However, the chair should not be balanced too far to the rear, as this increases the risk of the chair tipping backwards. It is important that you take time trying out a balance that suits your body and driving technique, so you can adapt the chair to be as easy to drive as possible without substantially increasing the risk of tipping.

You should always have someone standing behind you when you try out the chair after adjusting its balance.

If you still feel unsure about the balance of your chair having tested it thoroughly, you should use anti-tip devices. When extended, these devices eliminate the danger of tipping backwards and are easily retracted when you no longer need them.



Fig. 10



Fig. 11

SETTINGS

Adjusting the balance of the wheelchair (Fig. 12)

- 1) Remove the rear wheel by pressing the quick release button and pulling the wheel straight off.
- 2) Use the 15 mm cap key in order to loosen the lock screw (1). Repeat this process on the other side.
- 3) You will now be able to push the rear axle forward or backwards along the horizontal frame tubing. Continue until you find a suitable setting.
- 4) It is important that the rear axle is in the same forward position on both sides of the frame. This is most easily verified by measuring the distance between the rear end of the horizontal tubing and the rear end of the wheel attachment. See the two-way arrow in Fig. 11. Use a tape measure or ruler to ensure the distance is the same on both sides.
- 5) Tighten the lock screws (1) on both sides.
- 6) Reattach the rear wheels to the rear axle of the wheelchair and push in the wheels as far as possible. Check that the quick release button has sprung out, confirming the quick release is in locked position.
- 7) Pull the wheels outwards to ensure they are firmly attached.



7) Adjusting the brakes

Please note! The effectiveness of the brakes is affected when the air pressure drops, the tyres become worn or when changing to a different type of tyre. As a result, the brakes' settings should be checked from time to time.

Adjusting the high brake (Fig. 12)

High brake are activated by pushing lever (1) forward until stop. The the rear wheel ar locked. Repeat on the other side.

- 1) Use a 5 mm Allen key in order to loosen the lock screw (1).
- 2) You will now be able to push the brake forwards and backwards. Adjust the brake so that it presses around 4 mm into the tyre while in locked position. Tighten the lock screw (1) using a 5 mm Allen key.
- 3) Adjust the brake on the other side by following steps 1 to 3.



Fig. 12

ACCESSORIES



Anti-tip devices (Fig. 13)

The two anti-tip devices are **extremely important accessories** which must be folded out and correctly adjusted in order provide adequate protection against the user tipping backwards. **NOTE!** You cannot use the anti-tip device with your feet to lift the front wheels to get over thresholds, curbs etc.

Folding out the anti-tip device:

1. Push the knob downwards (1).
2. Fold out the anti-tip device, pointing backwards (2).
3. Repeat on the other anti-tip device.

Adjusting the anti-tip device:

- 1) Back up the wheelchair against a wall, Check that the rear end of the anti-tip wheel (3) is in line with or behind the rear wheel, must not be in front of the rear wheel.
- 2) Adjust when needed (3) by setting the anti-tip device in one of the five positions (4).

Folding in the anti-tip devices:

1. Push the knob downwards (1).
2. Fold the anti-tip device under the seat.
3. Repeat on the other anti-tip device.

Side guards (Fig. 14)

The side guards prevent clothing and loose items from becoming jammed in the wheelchair's spokes and also stop dirt from the wheels getting onto the user's clothing. The side guards are fitted with a soft upper section that folds down upon load, for example, when the user transfers to and from the wheelchair. You can place your hands on the side guards while pulling yourself up and down. The side guards can be removed, during transportation, for example, by pulling them up vertically to release them from their attachments.



Fig. 13



Fig. 14

ACCESSORIES

Armrests (Fig. 15)

The armrests can be adjusted both horizontally and vertically.

Adjusting the armrest horizontally:

1. Push and hold in the button on the inside of the armrest (1).
2. The armrest can be moved backwards and forwards while the button is pressed in.
3. Release the button at one of the 5 different positions.

Adjusting the armrest vertically:

1. Push and hold in the button on the outside of the armrest (2).
2. The armrest can be moved upwards and downwards while the button is pressed in.
3. Release the button at one of the 4 different positions.

The armrests can be removed, during transportation, for example, by pulling them up vertically to release them from their attachments.

Push handles (Fig. 16)

Push handles are used by assistants to drive the user in the wheelchair. The push handles can be adjusted vertically and they can also be folded in.

Adjusting the push handles vertically:

1. Pull the lever outwards (2).
2. The push handle can now be moved either upwards or downwards.
3. When reaching your desired position, fold the lever in.

Folding in the push handle:

1. Push and hold in the button on the upper section of the push handle (1).
2. When the button is pressed in, the push handle can be retracted.
3. Release the button.



Fig. 15



Fig. 16

ACCESSORIES

Hip belt (Fig. 17)

A hip belt (positioning belt) from a third part that fulfil the demands in MDR EU 2017/745 can be fitted without affecting conformity to the CE Mark standard. Should be fitted around the frame's tubing at one of the green locations indicated in Fig. 17. Alternative using Panthera hip belt attachments.

TRANSPORTATION

Panthera recommends the user to transfer to a regular car seat secured by a seat belt. This is the safest way to sit during transport. If you do not have the possibility for that and therefore stay sitting in the wheelchair during transport, it is extremely important to follow the instructions below.

For information on securing the wheelchair during transportation while the user remains in the wheelchair, see page 17.



Fig. 17



TRANSPORTATION

Assembling and disassembling the wheelchair (Fig. 18, 19 and 20)

When transporting the wheelchair, in a car, for example, the backrest can be folded and the rear wheel detached.

Lowering the backrest, Fig. 19:

- 1) Release the side guards and armrests, if necessary, and pull them up vertically.
- 2) Remove the seat cushion if necessary.
- 3) Pull the wire (1) and lower the backrest.

Detaching the rear wheel Fig. 20:

- 1) Push the quick release button (1).
- 2) Pull the wheel straight off.

Attaching the rear wheel, Fig. 20:

- 1) Push the quick release button (1).
- 2) Insert the wheel onto the rear axle and then push it in as far as possible.
- 3) Check that the button has sprung out (1), confirming the quick release is in locked position.
- 4) Pull the wheel outwards to ensure it is firmly attached.

Detaching the foot support, Fig 20:

- 1) Push the button (1) and at the same time push the foot support downwards
- 2) Turn the foot support outward (2).
- 3) Lift the foot support straight up to release it (3)



Fig. 20



Fig. 18



Fig. 19

TRANSPORTATION

Securing the wheelchair in a vehicle (Fig. 21 and 22)

During transportation, the wheelchair must always be facing in the direction of travel while the user is sitting in the chair.

An exception may be made if the vehicle is fitted with a device designed in accordance with Bus Directive 2001/85/EG, Appendix VII, Item 3.8.3. In such cases, the user may travel without a restraint system with the wheelchair facing in the opposite direction to which the vehicle is travelling.

The wheelchair must always be secured to the vehicle in four locations

Securing the wheelchair

- 1) Secure the straps around the tubing above the two castors. See Fig. 22.
- 2) Fasten the two straps around the rear axle. See Fig. 23. **Please note!** Do not attach metal hooks directly against the rear axle.
- 3) Pull the wheelchair backwards and fully tighten the rear straps to ensure the wheelchair is secured and cannot be moved forwards or backwards.
- 4) If the wheelchair is fitted with brakes, ensure these are activated.
- 5) We also recommend that the anti-tip devices are folded out.
- 6) Ensure that all straps and bands are fully fastened to the profile rail on the floor of the vehicle.
- 7) Check that all straps and belts have been tightened sufficiently



Fig. 21



Fig. 22

TRANSPORTATION

Securing the user (Fig. 23 and 24)

If the user remains in the wheelchair during transportation, we recommend that the backrest is level with or above the user's shoulders.

The user must be secured in the vehicle using a three-point seatbelt in order to minimise the risk of injury to the head or chest in conjunction with braking or potential collision.

The vehicle's seatbelt must remain in contact with the user's body. Seatbelts may not be separated from the user's body by any part of the wheelchair. See Fig. 24 and Fig. 25.

Unsecured accessories in the wheelchair must be removed in order to minimise the risk of injury to the user or fellow passengers.



Fig. 23

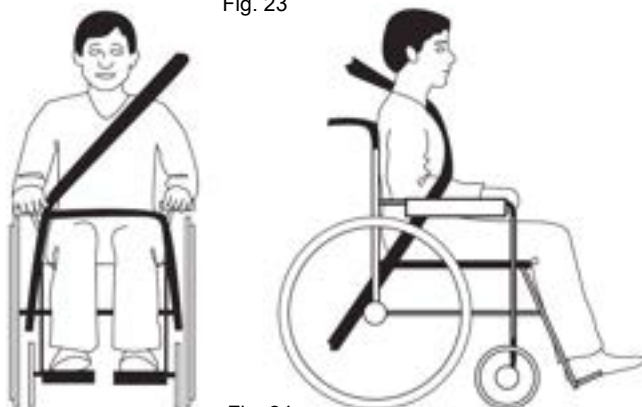

Fig. 24

CRASH TEST

Panthera S3 Swing models have successfully undergone crash testing

Panthera S3 Swing models have been crash tested in accordance with ISO-7176-19:2008 and ISO-10542:2000, and are thereby approved for transportation in service mobility vehicles.

Crash testing was carried out by SP Technical Research Institute of Sweden

Date of test:: 29/10/2015

The following materials were used during crash testing:

Restraint system: HandiSecure HS01-A

User seatbelt: HandiSecure HS01-A three-point seatbelt with high deflector.

Test dummy: Hybrid III dummy (weight 76.3 kg)

For more information about seatbelts and restraint systems, contact the manufacture, Handicare.

Specification of wheelchair used for crash test

Full chassis (width 39 cm), Full backrest (width 39 cm, height 40 cm), Foot support (width 39 cm), Rear wheel (std 24" with titanium push rim), High brake, Anti-tip device, Side guards with cover, Cushion (width 39 cm, 2.5 cm).

Wheelchairs configured in any other way cannot be guaranteed to meet the requirements stipulated by ISO-7176-19:2008 and ISO-10542:2000.

MAINTENANCE

Your Panthera model was designed for rigorous daily use over a number of years, and as such, some parts must be regularly checked.

If using your wheelchair in more demanding environments, such as sand or saltwater, you must examine and clean your wheelchair more often than what is specified below.

Storage

When storing your wheelchair for four months or more, ensure it is kept in a dry, warm area. After storage, check the tyre air pressure and the condition of the upholstery.

Ongoing maintenance

For ongoing maintenance, you will need the following:

- car shampoo or detergent.
- degreasing agent (for removal of severe dirt).
- multi-purpose oil, for example, CRC 5-56.

Once a month, you must:

- Wipe the wheelchair chassis over with car shampoo or detergent using a damp cloth. To remove severe dirt, use a degreasing agent. After cleaning, lubricate all movable parts with oil.
- Clean the Castor fork casing (between the wheel and the fork). Hair and dust, etc. often accumulate here which can damage the bearing. Use a 4 mm Allen key in order to loosen the screw. Remove the bolt and detach the Castor. Clean the washers between the wheel and the fork and wipe the outside of the wheel bearing with a cloth. Apply a drop of oil to each bearing. When finished, reassemble the components.
- Lubricate the rear wheel's quick release. Remove the rear wheel by pressing the quick release button and pulling the wheel straight off. Distribute a few drops of oil over the quick releases at the hub of the rear axle. If you drive in rain, sand, salt or slush, or rarely remove the rear wheel, you should lubricate the quick releases more regularly.
- Pump up the tyres. Unscrew the cap from the tyres' air valves. Fill the tyres with air at the correct pressure using a suitable valve adaptor (see Technical facts).
- Check that all the screws and nuts are securely fastened. Tighten them where necessary.
- Ensure the wheelchair has not sustained any damage. In the event of damage, immediately contact your local supplier or the team at Panthera AB.

Twice a year, you must:

- Lubricate the movable parts of the brakes with a few drops of oil.
- Lubricate the bushing at the joint of the backrest. Use two 10 mm cap keys in order to hold down the bolts and loosen the nuts. Lubricate the bushings with a few drops of oil. When finished, reassemble the components.
- Wash the upholstery when necessary. Machine wash the seat upholstery, backrest upholstery and seat cushion cover at 60°C. Before washing, attach the male velcro to female to prevent the upholstery to get rugged by the velcro.

Prevent spread of infection

The whole wheelchair should be wiped of with a cloth soaked with alcohol based antiseptic agent with tenside. Wash the back rest and seat according to the instructions.

Help with service and repair

For help with service and repair, contact your local supplier first (Assistance centre). You can also contact the team at Panthera AB if you wish.

Instructions for reconditioning can be downloaded at www.panthera.se

If you need to send the wheelchair to the workshop for repair:

1. Fold the backrest of the wheelchair and fix it with a few layers of tape.
2. Bubble wrap the wheelchair and add cushioning materials to the bottom of the box.
3. Nest the wheelchair in a sturdy shipping box.
4. Fill the voids with foam padding and cushioning materials.
5. Close and seal the box with several layers of adhesive tape on each side of the package.

Replacement of wear parts (Fig. 25 and 26)

Wear parts such as tyres, inner tubes and Castors can be ordered from Panthera, with the work carried out at home for those able to do so. Otherwise, contact your wheelchair provider or Panthera.

www.panthera.se

To replace these yourself, do as follows: You need these tools: Tyre changing tools and a 4 mm allen key

Replacing tyres and inner tubes: (Fig. 25)

- 1) Order parts from Panthera in the correct dimension. Measure the diameter of the castor in mm and the rear tyre has the size printed on the side.
- 2) Remove the rear wheel by pressing the quick release button and pulling the wheel straight off.
- 3) Remove the tyre and inner tube using suitable tools. The method is the same as that used for changing the tyre and inner tube on a bicycle wheel.
- 4) Carefully fit the inner tube and tyre to ensure the inner tube is not punctured. Pump up the tyre.
- 5) Reattach the wheel to the wheelchair, taking care to ensure the quick release button springs out so the wheel is securely fastened to the hub. Pull the wheel outwards to ensure it is firmly attached. Spin the wheel to ensure the tyre has been fitted correctly and the wheel is completely circular.

Replacing Castors: (Fig. 26)

- 1) Order parts from Panthera in the correct dimension.
 - 2) Detach the Castor using a 4 mm Allen key. Observe how the Castors' bushings are mounted – there is a right (1) and a left (2) version.
 - 3) When attaching the new Castor, hold down both bushings using your thumb and index finger and then guide the Castor into the fork track.
- At reassembly of castor wheel after cleaning or service you should always check the bolt for thread locking (blue, red or green colour), which indicates sufficient thread locking. If the tread locking is missing, always order a new bolt or apply a small amount of weak thread locking.
- 4) Tighten fully using a 4 mm Allen key. Ensure that the Castor turns easily



Fig. 25



Fig. 26

GUARANTEE AND LIFESPAN

Lifespan: The lifespan of a Panthera product depends on how much wear and tear it is exposed to and how thorough you are with maintenance.

When reaching the end of its lifespan, the wheelchair must be handed in to your wheelchair provider or Panthera AB to be recycled.

Guarantee

Panthera AB offers a five-year factory guarantee on the wheelchair chassis. For other parts there is a guarantee of 12 months (with the exception of wear parts).

- The guarantee covers product faults attributable to defects relating to design, material or manufacturing.
- The guarantee does NOT cover faults attributable to normal wear and tear, negligent maintenance, handling errors, incorrect storage, incorrect assembly on the part of the purchaser, adjustments and use of products from other supplies without obtaining Panthera AB's written consent or deterioration attributable to repairs carried out on the purchaser's own initiative.

Reuse

The Panthera S3/U3 models are suitable for reuse. Prior to being reused, the wheelchair must be cleaned, disinfected and dispatched to an authorised reseller for inspection.

CONFORMITY (Fig. 27 and 28)

Details of the wheelchair's conformity with standards can be found on the underside of the chassis at the front.

See page 3 for explanation of symbols.



Fig. 27



Fig. 28

TECHNICAL FACTS

S3 SWING					
Model code	G547	G547	G547	G547	G547
Seat width (cm)	36	39	42	45	50
Total width	57	60	63	66	71
Total length	93	93	93	93	93
Total height	64-84	64-84	64-84	64-84	64-84
Seat					
Seat angle	4°	4°	4°	4°	4°
Height of seat at rear	43	43	43	43	43
Height of seat at front	45	45	45	45	45
Depth of seat	40	40	40	40	40
Backrest					
Backrest height	20-45	20-45	20-45	20-45	20-45
Back angle back-forw.	13,3-(-12)°	13,3-(-12)°	13,3-(-12)°	13,3-(-12)°	13,3-(-12)°
Rear wheel diameter	24"	24"	24"	24"	24"
Push rim diameter	555 mm	555 mm	555 mm	555 mm	555 mm
Rear wheel camber	2,2°	2,2°	2,2°	2,2°	2,2°
Castor diameter	120 mm	120 mm	120 mm	120 mm	120 mm
Footrest to seat - meas.	40-48 cm	40-48 cm	40-48 cm	40-48 cm	40-48 cm
Transport dimensions					
Width	49	52	55	58	63
Length	78	78	78	78	78
Height	50	50	50	50	50
Static stability	5°	5°	5°	5°	5°
Weights					
Total (g) *	9400	9500	9600	9900	10300
Transport (g), heaviest part	4600	4700	4800	5000	5500
Max. userweight (kg)	100	100	100	150	150**
Min turning space (cm)	90	90	90	90	90
Air pressure in tyres (bar/kPa)	8 / 800	8 / 800	8 / 800	8 / 800	8 / 800
Material: chassis / backr.	Chrome molybdenum tubing				
Material: upholstery	Polyurethane coated polyester				
Upholstery, cushion fire tested in accordance with::	ISO 7176-16				
Wheelchair classification	B; indoor/outdoor				
* Weights were taken with brakes installed.					
** Seat width of 50 cm exceeds the total recommended width of the wheelchair in accordance with the standard. Bear this in mind at emergency exits.					

Panfihra AB reserves the right to make technical changes if required

TECHNICAL FACTS

S3 SWING SHORT						
Model code	G553	G553	G553			
Seat width (cm)	33	36	39			
Total width	54	57	60			
Total length	78-90	78-90	78-90			
Total height	64-84	64-84	64-84			
Seat						
Seat angle	4°	4°	4°			
Height of seat at rear	43	43	43			
Height of seat at front	45	45	45			
Depth of seat	35	35	35			
Backrest						
Backrest height	20-45	20-45	20-45			
Back angle back-fow.	13,3-(-12)°	13,3-(-12)°	13,3-(-12)°			
Rear wheel diameter	24"	24"	24"			
Push rim diameter	555 mm	555 mm	555 mm			
Rear wheel camber	2,2°	2,2°	2,2°			
Castor diameter	120 mm	120 mm	120 mm			
Footrest to seat - meas.	38-48 cm	38-48 cm	38-48 cm			
Transport dimensions						
Width	46	49	52			
Length	78	78	78			
Height	50	50	50			
Static stability	5°	5°	5°			
Weights						
Total (g) *	8900	9000	9100			
Transport (g), heaviest part	4400	4500	4600			
Max. userweight (kg)	100	100	100			
Min. turn.space (cm)	85	85	85			
Airpressure (bar / kPa)	8 / 800	8 / 800	8 / 800			
Material: chassis / back	Cromemolybden					
Material: upholstery	Polyurethane cotaded polyester					
Upholstery and cushion fire tested according to:	ISO 7176-16					
Wheelchair class	B; indoor / outdoor					
* Weights with mounted brake						

TECHNICAL FACTS

S3 SWING Low 0°

Model code	G5837	G5837	G5837	G5837	G5837
Seat width (cm)	36	39	42	45	50
Total width	57	60	63	66	51
Total length	93	93	93	93	93
Total height	61,5-81,5	61,5-81,5	61,5-81,5	61,5-81,5	61,5-81,5
Seat					
Seat angle	0°	0°	0°	0°	0°
Height of seat at rear	39	39	39	39	39
Height of seat at front	39	39	39	39	39
Depth of seat	35,37.5,40	35,37.5,40	35,37.5,40	35,37.5,40	35,37.5,40
Backrest					
Backrest height	20-45	20-45	20-45	20-45	20-45
Back angle back-fow.	13,3-(-12)°	13,3-(-12)°	13,3-(-12)°	13,3-(-12)°	13,3-(-12)°
Rear wheel diameter	24"	24"	24"	24"	24"
Push rim diameter	555 mm	555 mm	555 mm	555 mm	555 mm
Rear wheel camber	2,2°	2,2°	2,2°	2,2°	2,2°
Castor diameter	120 mm	120 mm	120 mm	120 mm	120 mm
Footrest to seat - meas.	40-48 cm	40-48 cm	40-48 cm	40-48 cm	40-48 cm
Transport dimensions					
Width	49	52	55	58	63
Length	78	78	78	78	78
Height	50	50	50	50	50
Static stability	5°	5°	5°	5°	5°
Weights					
Total (g) *	9370	9470	9570	9770	10170
Transport (g), heaviest part	4570	4670	4770	5070	5470
Max. userweight (kg)	100	100	100	150***	150***
Min. turn.space (cm)	90	90	90	90	90
Airpressure (bar / kPa)	8 / 800	8 / 800	8 / 800	8 / 800	8 / 800
Material: chassis / back	Cromemolybden				
Material: upholstery	Polyurethane cotaded polyester				
Upholstery and cushion fire tested according to:	ISO 7176-16				
Wheelchair class	B; indoor / outdoor				

* Weights were taken with brakes installed.

** Seat width of 50 cm exceeds the total recommended width of the wheelchair in accordance with the standard. Bear this in mind at emergency exits

TECHNICAL FACTS

S3 SWING LONG					
Model code	G5818	G5818	G5818	G5818	G5818
Seat width (cm)	36	39	42	45	50
Total width	57	60	63	66	51
Total length	98	98	98	98	98
Total height	64-84	64-84	64-84	64-84	64-84
Seat					
Seat angle	4°	4°	4°	4°	4°
Height of seat at rear	43	43	43	43	43
Height of seat at front	45	45	45	45	45
Depth of seat	37,5-45	37,5-45	37,5-45	37,5-45	37,5-45
Backrest					
Backrest height	20-45	20-45	20-45	20-45	20-45
Back angle back-fow.	13,3-(-12)°	13,3-(-12)°	13,3-(-12)°	13,3-(-12)°	13,3-(-12)°
Rear wheel diameter	24"	24"	24"	24"	24"
Push rim diameter	555 mm	555 mm	555 mm	555 mm	555 mm
Rear wheel camber	2,2°	2,2°	2,2°	2,2°	2,2°
Castor diameter	120 mm	120 mm	120 mm	120 mm	120 mm
Footrest to seat - meas.	40-48 cm	40-48 cm	40-48 cm	40-48 cm	40-48 cm
Transport dimensions					
Width	49	52	55	58	63
Length	68	68	68	68	68
Height	50	50	50	50	50
Static stability	5°	5°	5°	5°	5°
Weights					
Total (g) *	9670	9770	9870	10070	10470
Transport (g), heaviest part	4870	4970	5070	5270	5670
Max. userweight (kg)	100	100	100	150***	150***
Min. turn.space (cm)	90	90	90	90	90
Airpressure (bar / kPa)	8 / 800	8 / 800	8 / 800	8 / 800	8 / 800
Material: chassis / back	Cromemolybden				
Material: upholstery	Polyurethane cotaded polyester				
Upholstery and cushion fire tested according to:	ISO 7176-16				
Wheelchair class	B; indoor / outdoor				
* Weights were taken with brakes installed.					
** Seat width of 50 cm exceeds the total recommended width of the wheelchair in accordance with the standard. Bear this in mind at emergency exits.					
*** Approved for 136kg userweight at crashtest ISO 7176-19;2001					

TECHNICAL FACTS

S3 SWING EXTENDED 25

Model code	G581	G581	G581	G581	G581
Seat width (cm)	36	39	42	45	50
Total width	57	60	63	66	51
Total length	95,5	95,5	95,5	95,5	95,5
Total height	64-84	64-84	64-84	64-84	64-84
Seat					
Seat angle	4°	4°	4°	4°	4°
Height of seat at rear	43	43	43	43	43
Height of seat at front	45	45	45	45	45
Depth of seat	35-42,5	35-42,5	35-42,5	35-42,5	35-42,5
Backrest					
Backrest height	20-45	20-45	20-45	20-45	20-45
Back angle back-forw.	13,3-(-12)°	13,3-(-12)°	13,3-(-12)°	13,3-(-12)°	13,3-(-12)°
Rear wheel diameter	24"	24"	24"	24"	24"
Push rim diameter	555 mm	555 mm	555 mm	555 mm	555 mm
Rear wheel camber	2,2°	2,2°	2,2°	2,2°	2,2°
Castor diameter	120 mm	120 mm	120 mm	120 mm	120 mm
Footrest to seat - meas.	40-48 cm	40-48 cm	40-48 cm	40-48 cm	40-48 cm
Transport dimensions					
Width	49	52	55	58	63
Length	68	68	68	68	68
Height	50	50	50	50	50
Static stability	5°	5°	5°	5°	5°
Weights					
Total (g) *	9370	9470	9570	9870	10270
Transport (g), heaviest part	4570	4670	4770	4970	5470
Max. userweight (kg)	100	100	100	150***	150***
Min. turn.space (cm)	90	90	90	90	90
Airpressure (bar / kPa)	8 / 800	8 / 800	8 / 800	8 / 800	8 / 800
Material: chassis / back	Cromemolybden				
Material: upholstery	Polyurethane cotaded polyester				
Upholstery and cushion fire tested according to:	ISO 7176-16				
Wheelchair class	B; indoor / outdoor				

* Weights were taken with brakes installed.

** Seat width of 50 cm exceeds the total recommended width of the wheelchair in accordance with the standard. Bear this in mind at emergency exits.

*** Approved for 136kg userweight at crashtest ISO 7176-19;2001

ANTECKNINGAR



Panthera AB reserves the right to make technical changes if required

art.nr:8822149, Rev. 2023-02 Publ. 2023-03-02



Panthera AB reserves the right to make technical changes if required

art.nr:8822149, Rev. 2023-02 Publ. 2023-03-02



Panthera AB, Gunnebogatan 26, SE-163 53 Spånga, Sweden
+46-8-761 50 40, www.panthera.se, panthera@panthera.se

the

OCAM